



emr



Değerli müşterimiz;

Dünya gün geçtikçe küreselleşirken, işletmeler de bu süreçte sürekli değişmekte ve dönüşmektedir. Gelişen ekonomik sistemler ticari sınırları ortadan kaldırırken, global değerler de işletmelere ve iç yapılarına entegre olmaktadır.

Bizler EMR Grup olarak büyümeyi ve küresel bir marka olmayı hedeflerken bu değerleri özümsemeyi ve geliştirmeyi prensip ediniyor, gelecek planlarımızı bu yönde oluşturuyoruz.

Üretim ve satışın her aşamasında doğaya, çevreye ve insana saygı perspektifinde hareket etmeyi kendimize birinci amaç ediniyoruz. Teknolojiyi insan yaşamını kolaylaştıracak inovatif ürünler geliştirmek adına kullanırken, geri dönüşüm politikalarımızı sürekli iyileştirmeyi arzuluyoruz.

Yatırımlarımızı dünya merkezli dizayn ediyor, global bir işletme olma hedefimizi sürekli yeniliyoruz. Evrensel değerler çerçevesinde üretim gerçekleştirmeyi, hizmet ve ürün kalitemizi devamlı iyileştirmeyi, doğayı korurken insana ve topluma fayda ekseninde hareket etmeyi benimsiyoruz.

Çalışanlarımızı, müşterilerimizi ve tedarikçilerimizi bir nevi partner olarak görüyor, birlikte büyüme, birlikte gelişme ve birlikte fayda sağlamayı kendimize temel amaç ediniyoruz.

Bu bağlamda, hazırlamış olduğumuz bu kataloğun siz değerli müşterilerimize katkı sunmasını diler, saygılar sunarız.

Dear colleagues;

While world is globalising day-by-day, companies are also continuously changing and transforming themselves. Developing economic systems are eliminating the trade barriers and global values are integrated to the companies and their internal structures.

As EMR Group, we are targeting the growth and to be a global brand, internalizing and developing these values and creating our future plan in this perspective.

We also aim to act with the perspective of respect for the environment, human and nature in the each stage of the production and sales process. We are looking forward to improve our recycling policy and developing the technology for facilitating human life by producing innovative products.

We have been designing our investments in the basis of the world and renewing our goals for being a global company. We are targeting to improve our production in the framework of universal values and continuously developing our service/product quality while preserving the nature and benefiting to human and society.

We see our staffs, our customers and our suppliers as our business partners and we goal to growth and provide benefits altogether.

In this context, we wish that our new catalogue would contribute to our valued customers.

ÖMER ÖZPEHLİVAN

Yönetim Kurulu Başkanı / Chairman of the Board

EMR Fermuar

EMR Grup, Fermuar, Tekstil ve Aksesuar faaliyetlerine ilk kez 1986 yılında başlamış olup, 1994 yılında Beylikdüzü'ndeki fabrikasında ilk fermuar üretimini gerçekleştirmiştir. 1996 yılında Hadımköy'de kurduğu 10.000 metrekarelik kapalı alana sahip fabrika binasında fermuar üretimini devam ettirmiştir. 1998 yılında yapılan yatırımla metal düğme, perçin, çitçit ve diğer metal aksesuarların üretimine başlamıştır.

EMR Fermuar dış kaplama tesisi ile birçok farklı, seçkin ve özel kaplama çeşidini kendi bünyesinde gerçekleştirmektedir. 2012 yılında müşterilerine daha etkin hizmet sunmak amacıyla deri etiket imalatına dönük yatırım gerçekleştirilmiş ve ürün yelpazesi daha da çeşitlendirilmiştir. 2013 yılında yapılan yatırım çerçevesinde dar dokuma üretimine başlamış, lastik, şerit ve diğer tüm dokuma ürünlerinin imalatına başlamıştır.

2014 yılında İngiliz fermuar firması Slik Zips ile işbirliğine gidilerek birçok Avrupalı giyim markasının onaylı tedarikçisi konumuna yükselmiştir.

250 kişilik profesyonel ve tecrübeli kadrosu, müşteri memnuniyeti için yarışan, yenilikçi, proje üretebilen, eğitimli ve eğitilmeyi seven, takım ruhuna uygun çalışmayı hedef edinmiş kişilerden oluşmaktadır. Fermuar siparişlerini müşterilerimizin yerine başından sonuna kadar takip edebilen planlama kadromuz sizlere zamanlama anlamında sorun yaratmamayı hedef edinmiştir.

Sonsuz renk kapasiteli şerit boyahane departmanımızda renklerin en hassas şekilde onaylanıp, renk haslıklarını testlerinde geçirilerek sizlere ulaştırılır. Elcik tasarım ve çizimlerinde çalışan profesyonel kadromuz, elcik ve aksesuarlarınızı üç boyutlu programlarda çizmekte ve bünyemizdeki CNC pantograflarda kalıplarını yapabilmektedir. Bu da gerek hız ve özgünlük gerekse de müşterilerimize sunduğumuz hizmet anlayışı yönünden EMR'nin önemli güçlerindedir.

EMR Fermuar naylon şerit üretiminde birçok yenilik ve farklılık kolaylıkla sunulabilmektedir. Araştırmacı ve geliştirici bir kadroyla çalışan EMR Fermuar anti bakteriyel fermuar, yanmaya dayanıklı fermuar, elastik şeritli fermuar ve su itici fermuarları da inovatif olarak geliştirdiği ürünler arasına katmıştır. Metal Fermuar parkurunda Amerikan Teknolojisi, dokuma parkurunda İsviçre teknolojisi, kursor boyamada Alman teknolojisi kullanan EMR Fermuar yatırımlara ve eğitime verdiği önemle ürün ve hizmet kalitesini en üst seviyeye çıkarmıştır. Bünyemizde kullanılan kimyasal hammaddeler, dünyaca kabul görmüş firmalardan titizlikle seçilmektedir.

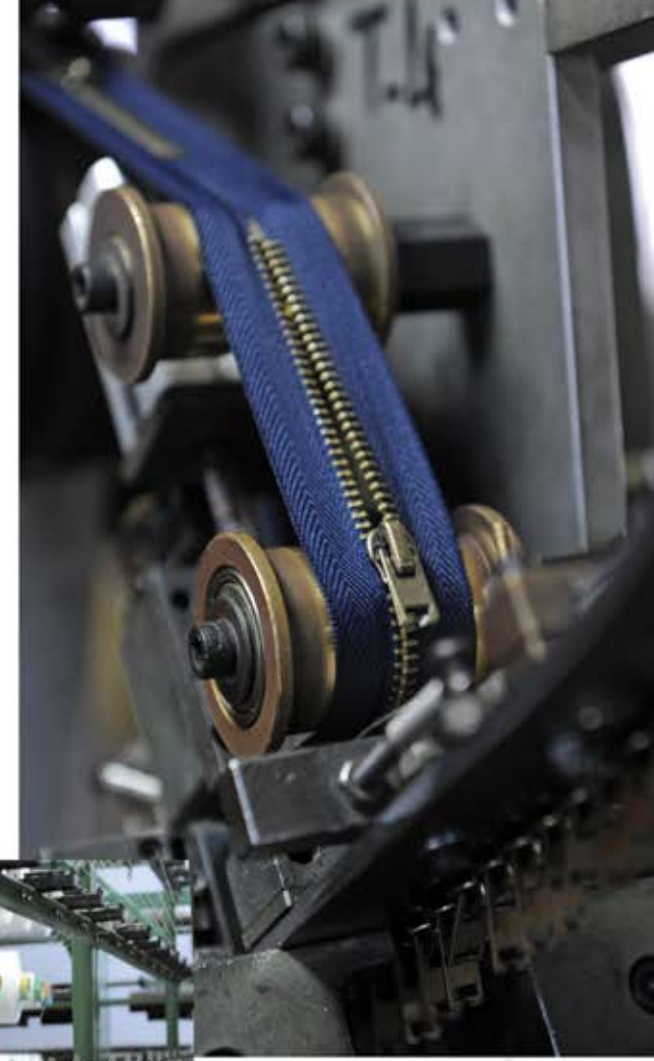

Siparişleriniz, EMR kalite kontrol ve paketleme bölümünde barkot etiketleme sistemiyle paketlenmektedir. Bu sayede ürünleriniz, depolama ve dağıtım aşamalarında rahatlıkla izlenebilmektedir.

EMR Fermuar hedeflerine ulaşabilmek için, sahip olduğu sistem belgesini 2010 yılında ISO 9001:2008 kalite yönetim sistemiyle yenilemiş, CLASS 1 sınıfında OEKO-TEX standart 100 belgesinin yanı sıra GOST-R (Rusya standartlarına uygunluk sertifikası) ve Rusya hijyen standartlarına uygunluk sertifikasına sahip olarak kalitesini kanıtlamıştır. Kalite laboratuvarımızda siparişleriniz TSE 11516 fermuar standardı baz alınarak mukavemet testlerine tabii tutulmaktadır.

Sürekli izlenen üretim aşamaları boyunca ürününüz size ulaşmadan önce farklı testler uygulanarak kalite uygunluk yöntemleriyle takip edilmektedir. Ayrıca yıkama sürtme, solma haslık testlerinin yanı sıra kursor boya dayanıklılık testleri de bünyemizde yapılmaktadır. Çevreye dost olmak anlayışından yolla çıkılarak oluşturulan arıtma kompleksiyle çevreye ve insan sağlığına saygı ve çocuk işçi çalıştırmamak ilke olarak benimsenmiştir.

Firmamızda üretilen tüm ürünler, Kalite Yönetim Sistemi çerçevesinde birçok üretim aşamasında örneklemeden seçilerek teste tabii tutulmakta ve bu test sonucunda elde edilen verilerin başarılı olması durumunda siz müşterilerimize sevk edilmektedir.

EMR

ermuar

EMR Group has started its zipper and accessory activities in 1986 and started to produce zippers for the first time in 1994 in Beylikduzu. It has continued to the zipper production with the 10.000 m²-covered areas factory building in Hadimkoy in 1996. We have begun to produce metal buttons, rivets, snap fasteners and other metal accessories in 1998.

EMR Zipper has established its own teeth plating plant in 2004, since then many different kinds of elegant and special coatings are carried out at our factory. By the year 2005, we have increased our capacity in order to provide more effective service to our customers, we have carried out investments at leather label field and our production range has been more diversified.

The cooperation with the British zipper company Slik Zips has started in 2014.

Our 250 professional and experienced staff that working for our customers' satisfaction, innovative view, capable of generating projects, well trained and work with the harmony of team spirit.

Our customers' different colour requests are prepared in our dyeing department, which has endless colour capacity, checked deeply and tested for colourfastness then sent them. Our colour card that including 750 different colours. It is the biggest colour catalogue in our sector and this is one of the important factor that distinguishing EMR Zipper from others.

EMR Zipper has the technological infrastructure to weave its own zipper tapes. Thus, many innovations and differences can be presented easily in the production of nylon zipper. EMR's researcher and developer staffs have been innovated and added to our product range such as antibacterial, fire-resistant, water-repellent and elastic tape zippers. By using American Technology at metal zipper production, Swiss technology at weaving department, German technology at slider painting, EMR has brought its quality to the highest level. EMR uses chemical raw materials that are always carefully selected from globally respected producers.

Your orders have been packaging by using barcode-labelling system by EMR quality control and packaging department. In this way, your products can be monitored easily during the storage and distribution processes.

In order to reach its goals, EMR has renewed its quality system certificate as ISO 9001:2008 and also we have Oeko-tex Standard 100 (Class: 1), Gost-R (Certificate of Russian standards) certificates. Your orders are subjected to resistance tests on the basis of TSE 11516. Also your products are continuously monitored at the production by applying different quality tests before you receive them. Also washing, friction, discoloration and colour durability tests are carried out at our own laboratory.

On the basis of understanding and respecting to the environment, EMR has its own treatment plant and EMR never employs child labour.

EMR Zipper is the only company that can produce all kinds of zippers, jeans buttons, rivets, snap fasteners, metal and leather labels, elastics, tapes, narrow weavings and hook and loop in a particular combination. EMR Zipper can produce the zipper sliders that used in its production and also can sell them to the zipper manufacturer around the world with its specific technological infrastructure.

All products manufactured by our company are tested according to Quality Management System and if the test results are corresponding the standards only in this case the products are shipped to our customers.



Metal





Dipli/Close End



Separe/Open End



Kombi/TwoWay



O Tipli/OType



X Tipli/XType



Çift Separe/Double Open End



R Tipli/RType



Standart Metal
no1-35mm



Standart Metal
no2-37mm



Standart Metal
no4-45mm



Standart Metal
no5-59mm



Standart Metal
no8-76mm



Standart Metal
no10-9mm



Standart Metal
no15-126mm



Simetri
no4-45mm



Simetri
no5-59mm



Simetri
no8-76mm



Extreme
no4-45mm



Extreme
no5-59mm



Extreme
no8-76mm



Brillant Bakur
Brillant Copper



Bakur
Copper

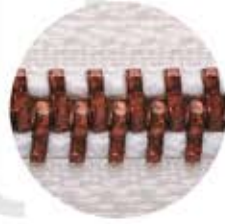

Bakur Oksit
Copper Oxide



Bakur Kalay
Copper Tin



Oksit
Oxide



Kalay Oksit
Tin Oxide



Antik Oksit
Antique Oxide



Miralay Oksit
Miralay Oxide



Pirinç MS70
Brass MS70



Pirinç MS85
Brass MS85



Brillant MS70
Brillant MS70



Brillant MS85
Brillant MS85



Light Altın
Light Gold



Alüminyum
Aluminum



Kalay
Tin



Brillant Free Nikel
Brillant Free Nickel



Free Siyah Nikel
Free Black Nickel



Elit Mix 1
Elite Mix 1



Elit Mix 2
Elite Mix 2



Elit Mix 3
Elite Mix 3



Elit Mix 4
Elite Mix 4



Otomatik
Auto-Lock



Maçalı
Flat Link



Kancalı
Hook Type



Telli
Wired



Kombi
Two Way



Kobra
Semi-Lock



Köprülü
Non-Lock



ZA
ZA



Döner Kombi
Reversible Two Way



Döner Otomatik
Reversible Auto-Lock



Döner Maçalı
Reversible Flat Link



Döner Kancalı
Reversible Hooked





Dein Kenntnis

Dipli/CloseEnd



Separe/OpenEnd



Kombi/TwoWay



OTipi/OType



XTipi/XType



Tip 3/D3
4,4mm



Tip 6/D5
5,7mm



Tip 6 jaws/D5 Jaws
5,7mm



Tip 7/D7
6,4mm



Tip 7 Jaws/D7 Jaws
6,4mm



Tip 8/D8
7,6mm



Tip 9/D10
7,6mm



Gümüş
Silver



Altın
Gold



Bakır
Copper



Oksit
Oxide



Antik Oksit
Antique Oxide



Fantik
Double Color

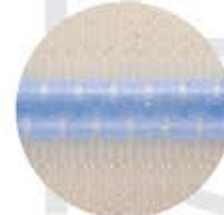

Şeffaf
Transparent

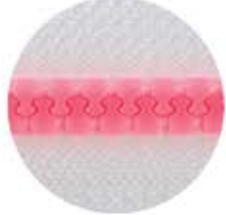

Pembe
Pink



Yeşil
Green



Sarı
Yellow



Turuncu
Orange



Otomatik
Auto-Lock



Maçalı
Flat Link



Kancalı
With Hook



Kombi
Otomatik
Two Way



3P Otomatik
3P Auto-Lock



Telli
Wired



Yaylı
Semi-Lock



ZA
ZA



Döner Kombi
Reversible
Two Way



Döner Otomatik
Reversible
Auto



Döner Maçalı
Reversible
Flat Link



Döner Kancalı
Reversible
Hooked



Çift Köprülü
Double
Non-Lock



Köprülü
Non-Lock



Naylon

Nylon



Dipli/Close End



Sebare/Open End



Kombi/TwoWay



O Tipi/OType



X Tipi/XType



Tip 5/N3
4,1mm



Tip 7/N4
5mm



Tip 10/N5
6mm

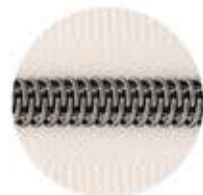

Tip 12/N7
6,4mm



Tip 15/N8
7mm



Tip 20/N10
10mm



Gümüş
Silver



Altın
Gold



Siyah Nikel
Black Nickel



Oksit
Oxide



SX12



ZT17



ZT18



Zt30



ZT28



SX19

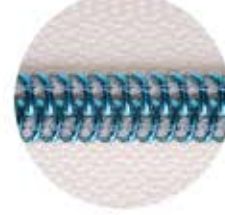

SX21



SX22



ZT10



SX13

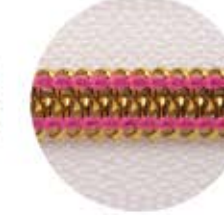

Fanatik
Double Color

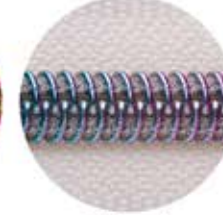

Gökkuşuğu
Rainbow



Otomatik
Auto-Lock



Maçalı
Flat Link



Kancalı
Hooked



Kombi
Two Way



Telli
Wired



3P Otomatik
3P Auto-Lock



3P Ters
3P Reverse



Döner Otomatik
Reversible Auto-Lock



Döner Maçalı
Reversible Flat Link



Döner Kancalı
Reversible Hooked



Köprülü
Non-Lock



Çift Köprülü
Double Non-Lock



Yaylı
Semi-Lock



Yaylı Ters
Reverse Semi-Lock

Gizli No 5
Invisible No 5



Gizli No 4
Invisible No 4



Gizli No 3 Dokuma
Invisible No 3 Woven



Gizli No 3 Tül
Invisible No 3 Lace



Gizli 3/13
4,2mm



Gizli 4/14
5mm



Gizli 5/15
6,2mm



TP1001



TP1002



TP1003



TP1004



TP1005



TP1006



TP1007



TP1008



TP1009



TP1010



TP1011



TP1012



TP1013



TP1014



TP1015



TP1016



TP1017



TP1018



TP1019



TP1020

fabrics

Puller ELECTK





KE1304



KE1305



KE0802



KE0608



KE0212



KE0618



KE0617



KE0609



KE1603X



KE1309X



KE1802



KE1519



KE0405



KE0701



KE1511



KE1509



KE1617



KE1316



KE1315



KE1515



KE0619



KE1702



KE1113



KE1120



KE1701



KE1513



KE1116



KE1816



KE1514



KE1520



KE1213



KE1517



KE1815



KE1133



KE0315











GE 0505



GE 1005



GE 1815



GE 1509



GE 1618



GE 0308



GE 0518



GE 2110



GE 2109



GE 1310



GE 1304



GE 0305



GE 1610



GE 1902



GE 1908



GE 1308



GE 1919



GE 1714



GE 1502



GE 2209



GE 2209



GE 1306



GE 2604



GE 1016



GE 1412



GE 2111



GE 2112



GE 1813



GE 1601



GE 0817



GE 0613



GE 2316



GE 2514



GE 2711



GE 2607



GE 2518



GE 0816



GE 0901



GE 2412



GE 2411





KE1417



KE1606



KE1605



GE1910



GE1910



KE1604



KE1013



KE0804



GE1607



GE0516



GE1619



KE1008



KE1007



GE2601



GE2109



GE0105



GE0103



KE1018



KE2020



GE0702



GE1606



GE1604



KE1412



KE1519 X



GE2106



GE2010



GE1004



KE1001



KE1005



KE1004



GE1315





ME 0504



ME 0503



AP 0113



AP 0119



AP 0213



AP 0205



AP 0111



AP 0120



AP 0102



AP 0207



AP 0104



AP 0101



AP 0117



AP 0115



AP 0109



AP 0110



AP 0107



AP 0203



ME1408



ME1407





DE 0101



DE 0102



DE 0103



DE 0104



DE 0105



DE 0106



DE 0107



DE 0108



DE 0109



DE 0110



DE 0111



DE 0112



DE 0113



DE 0114



4003



4008



4034



4025



4011



4012



4015



4006



4013



4016



4026



4002



4009



4004



4005



4033



4024



kullanım koşulları | Considerations For The Use Of The Zipper

- Ağır ve kalın kumaşlı ürünlerde; ince fermuar kullanmayınız.

1 *If the fabric is heavy and thick products; do not use low performance zipper.*
- Kumaş kalınlığı ve ağırlığına uygun mukavemet değerlerini karşılayacak fermuar kullanılmaması durumunda fermuarda patlamalar, kürsör ve elciklerde kırılmalar yaşanabilir.

2 *The selected zippers must be suitable for the thickness and weight of the fabric, if not zipper can be damaged or sliders and pullers can be broken.*
- Oksit kaplamalı fermuarları; parça boyamalı ve ağır koşullu endüstriyel yıkama işlemi uygulanan ürünlerde kullanmayınız.

3 *Do not use the Oxide coated zipper for piece dyeing and hard industrial washing operations.*
- Dar giysilerde; kesinlikle gizli fermuar kullanmayınız.

4 *Do not definitely use invisible zipper for tight clothes.*
- Dikim öncesi uzun süreli bekleyecek olan fermuarlar; poşet içerisinde ve rutubetsiz ortamlarda muhafaza edilmelidir.

5 *If the zippers wait for along time before the sewing, they must be kept in original package in suitable storage without humidity.*
- Boyalı kürsörlü fermuar dikilmiş ürünlerin yıkamasında kimyasal maddeler kullanılmamalıdır. Yıkama işlemi 30 ila 50 ° C sıcaklıklarda yapılmalıdır.

6 *Do not use the chemicals into washing with the painted slider on zippers. Washing process must be between 30 and 50 °C.*
- Fermuar dikilmiş ürünlerin buharlı ütü ve presleme işlemine tabii tutulması sonrası soğutulduktan sonra ambalajlanması gerekir.

7 *After ironing, steaming process the garments must be waited for cooling and then package the goods*
- Fermuar dikilmiş ürünlerin pres ütülerle ütülenmesi sırasında; fermuar üzerine ve kürsörlere sert bir şekilde vurulmamalıdır.

8 *When ironing with press machine, do not hit hardly on zipper and slider.*
- Fermuarların dikimi sırasında; kumaşla fermuar arasında kürsörün rahatça hareket edebileceği kadar mesafe bırakılmalıdır.

9 *While sewing the zippers, it must be sufficient distance between the zipper and the fabric for easily movement of the slider.*
- Fermuarın ürün üzerine dikiminden önce; fermuar şeridinin eninden keserek daraltma yapmayınız. Kesme yapılması halinde çözgülerin ayrılması nedeniyle, fermuar dağılabilir.

10 *Do not cut the zipper tape transverse to narrow down the zipper before the sewing it. In this case the zipper tape can be removed.*
- Fermuarın açılıp kapatılması sırasında, kürsöre iplik veya kumaş parçasının sıkışmamasına dikkat ediniz.

11 *During opening and closing the zipper, be careful not to pinch the slider yarn or cloth.*
- Açık renkli giysilerde; metal oksit kaplamalı fermuarları kullanmayınız. Metal oksit kaplamalı fermuarlar, yıkama ve kullanım sırasında açık renk kumaş lekeleyebilir.

12 *In a light-colored clothing; Do not use metal oxide coated zippers. Metal oxide-coated zippers, can stain on light-colored fabric during washing and useing.*
- Alt Stopun, ürün üzerinde bulunması istenmiyorsa; dikim öncesi kesilmemelidir. Eğer kesim yapılacaksa, dikim sonrası yapılmalıdır.

13 *If you do not want to use the bottom stop please cut it after sewing.*
- Naylon fermuarların monofil dişleri çok hassas olduğundan, dişlerde en ufak bir zedelenmeye ve ezilmelere sebebiyet verilmemelidir.

14 *Because of monofilament nylon zipper teeth are very sensitive, not to cause the slightest damage to the teeth and to stomping.*
- Fermuar dikilmiş ürünlerin yıkanması sırasında; fermuar mutlaka tam olarak kapatınız, kürsörü kilitleyiniz ve giysiyi ters çeviriniz.

15 *During washing of the product; You must fully close the zipper, you lock the slider and turn the clothes upside down.*
- Separe fermuarların karşılıklı şeritlerini birbirleriyle karıştırmayınız.

16 *Please do not mix zippers' mutually tapes with each other.*
- Fermuarın ürüne dikimi sırasında; makineye, dikilecek fermuar cinsine ve fermuarın üzerine dikileceği ürüne uygun dikim ayağı kullanınız.

17 *While sewing the zippers; chose the available stitch foot according to the sewing machine, to fabric and to the type of the zipper.*
- Bebek ve çocuk giysilerinde; özel kilitli ve yanmaz fermuar kullanınız.

18 *For baby and child's clothes; use special locked and fireproof zipper.*
- Gizli fermuarların ürün üzerine dikimi sırasında; mutlaka dikiş makinenize özel gizli fermuar dikim aparatı kullanınız.

19 *While sewing the invisible zippers; chose the available sewing foot according to the sewing machine.*
- Fermuar dikimi öncesi, dikilecek yüzey üzerine yapıştırıcı ve solüsyon uygulanması durumunda, bunların dişlere bulaşarak, dişleri bozmamasına dikkat ediniz.

20 *Before sewing the zipper, if applicate the glue and special solution on the material surface, must be protected the teeth of the zipper.*
- Çanta, ayakkabı ve bot imalatında; solüsyon ve peluşların fermuar dişleri arasına girerek, zarar vermemesine dikkat ediniz.

21 *During production of the bags, shoes and boats; keep away the zipper teeth from glue and pelush.*
- Fermuarların korozyon dayanım direncinin yüksek olmasını istiyorsanız, laklı fermuar kullanımını tercih ediniz.

22 *If you want to increase the corrosion resistance of zipper, prefer to use the varnished zipper.*
- Fermuarların metal dedektöründen problemsiz olarak geçmesini istiyorsanız; no manyetik ve free nikel kaplamalı fermuar tercih ediniz.

23 *In order to passing zips through needle detector without any problem, you should prefer the free nickel coated and no magnetic zippers.*

FERMUAR PERFORMANS ÖZELLİKLERİ BS3084

zipper performance tests

TEST TANIMI	DESCRIPTION OF TEST	BİRİM UNIT	PERFORMANS KODU (A) PERFORMANCE CODE	PERFORMANS KODU (B) PERFORMANCE CODE	PERFORMANS KODU (C) PERFORMANCE CODE	PERFORMANS KODU (D) PERFORMANCE CODE	PERFORMANS KODU (E) PERFORMANCE CODE
ELÇİK KOPMA MUKAVEMETİ	1 STRENGTH OF PULLER ATTACHMENT	N	70	80	200	250	300
ALT STOP MUKAVEMETİ	2 STRENGTH OF CLOSE END	N	35	60	80	100	140
ÜST STOP MUKAVEMETİ	3 STRENGTH OF TOP STOP	N	50	70	90	110	130
KUTU PİM MUKAVEMETİ	4 STRENGTH OF OPEN END FASTENER BOX	N	40	70	90	120	150
ÇALIŞMA DİRENCİ	5 RESISTANCE TO RECIPROCATION	CYCLES	500	500	500	500	500
ENİNE ZİNCİR MUKAVEMETİ	6 LATERAL STRENGTH OF FASTENER	N	150	200	250	370	470
ENİNE KUTU PİM MUKAVEMETİ	7 LATERAL STRENGTH OF OPEN END ATTACHMENT	N	40	70	90	120	160
KÜRSÖR KİLİT DİRENCİ	8 STRENGTH OF SLIDER LOCKING FORCE	N	10	15	25	40	60
KÜRSÖR TEK TARAFA TUTUNMA MUKAVEMETİ	9 OPEN END FASTENER SINGLE STRINGER SLIDER RETENTION	N	-	60	70	90	120

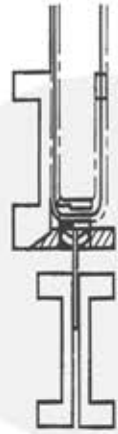

1

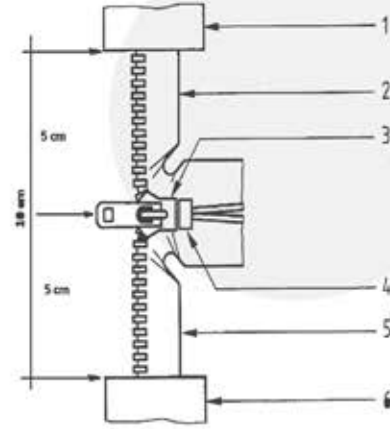

2

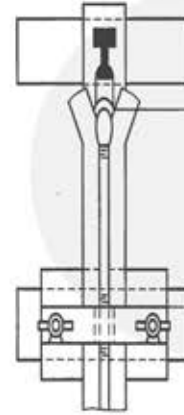

3

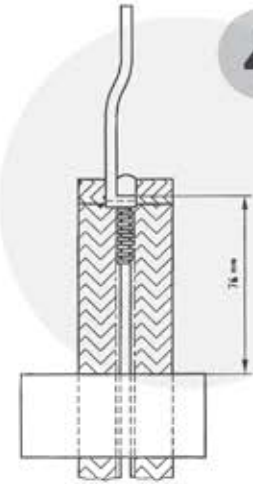

4

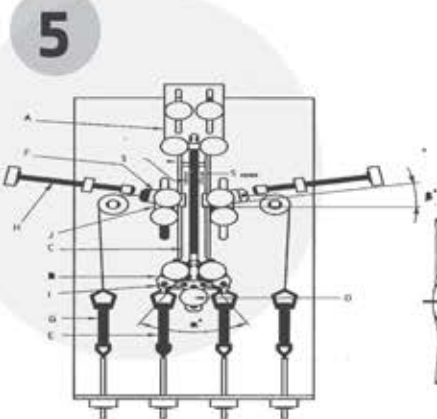

5

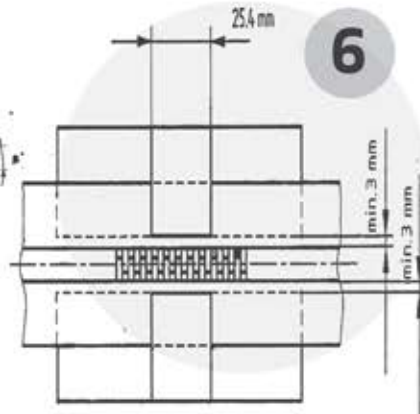

6

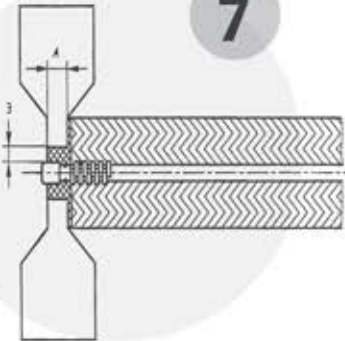

7

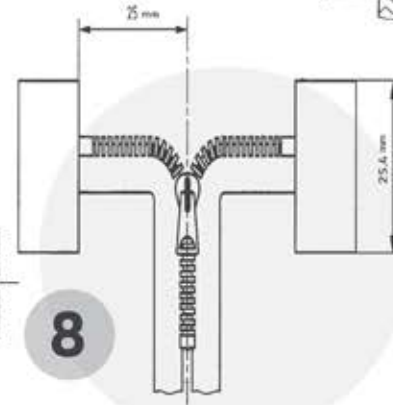

8



9

www.emrfermuar.com

emr

EMR FERMUAR SAN. TİC. A.Ş.
Akçaburgaz Mh. 3078. Sk. No:1/3 Esenyurt / İSTANBUL

+90 (212) 886 69 70
+90 (212) 886 85 64 (Planlama)
+90 (212) 886 69 79 (Pazarlama)

suleyugursoy.net